



DRADER

INJECTIWELD

MODEL 245

Instruction Manual & User Guide

REVISION 1.0



Table of Contents

1. Read These Instructions to Protect Yourself and Others.....	4
2. General Information.....	4
3. Safety.....	5
4. New Welder Details	6
5. Parts and Service.....	6
6. Operating Instructions.....	7
7. Welding Joint Types	13
8. Proper Welding Techniques – General Considerations	14
9. Proper Welding Techniques – Drader Injectiweld	15
10. Proper Welding Techniques – Drader Injectiweld – Fillet Welds	16
11. Proper Welding Techniques – Drader Injectiweld – Butt Welds.....	17
12. Daily Maintenance – Drader Injectiweld	18
13. Compliance Statements For Drader Injectiweld Products.....	19
14. Warranty.....	21

To ensure safe work practices and correct operation of the **245 Injectiweld**, the manufacturer strongly recommends before welding, all operators read this manual in its entirety.

Congratulations on your purchase of Drader Manufacturing's plastic welding equipment.

To get the most out of your purchase, be sure to read this manual carefully and keep it on hand for future reference. The Injectiweld plastic welding system uses a combination of heated tip and injection pressure to form its welds. The hot (interchangeable) tip melts the surface of the plastic and creates a weld zone into which molten plastic is injected. There is a physical mixing of the weld bead and the plastic.

While every effort has been made to ensure the information in this manual is accurate and complete, in no event shall our company be liable for any direct, indirect, punitive, incidental, special consequential damages, to property or life, whatsoever arising out of or connected with the misuse of our products. Drader Manufacturing reserves the right to change the specifications of the products described herein at any time without written notice.

1. Read These Instructions to Protect Yourself and Others

Be aware, serious injury or death may result if welding equipment is not properly installed, used, and maintained. Misuse of this equipment and other practices can be both hazardous and dangerous to the operator and any persons in the general work area. The operator and supervisor must read and understand the following safety warnings and instructions before using this welding equipment. Use of this welding equipment must be done in adherence with the rules and regulations outlined by the local occupational health and safety organization having jurisdiction over the location where the welder will be operated especially if the welding equipment will be used in a confined space.

The Drader Injectiweld is to be operated by qualified people with adequate training in accordance with this manual. Only authorized service personnel should perform any maintenance that requires opening the welder housing.

Opening the welder housing voids the Drader Warranty and may expose the user to Dangerous Voltages.

2. General Information

Information, presented in this manual should be read, understood and followed for the safe and effective use of this equipment. Safety instructions specially pertaining to this unit appear throughout this manual, highlighted by a symbol that identifies levels of hazard. There are also welding tips and hints throughout this manual that will make your welds better and your Drader Injectiweld usage more effective.

Symbols used throughout this manual:



HIGH VOLTAGE - The lightning flash symbol will alert the user to the presence of "dangerous voltage" that may be of sufficient magnitude to constitute a risk of electric shock.



HOT SURFACE - The heat symbol will alert the user to the fact that they might get a serious burn if they touch the part.



WARNING / CAUTION - The exclamation point symbol will alert the user to important operating and maintenance instructions.



TIP - The Injectiweld symbol identifies tips and hints to obtain the most efficient operation of this tool.

3. Safety

The operation, maintenance and troubleshooting of the Injectiweld requires practices and procedures which ensure personal safety and the safety of others.

Read and follow the safety instructions in this manual.

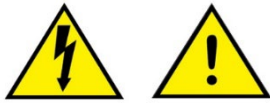

The Injectiweld is equipped with a ground-contact plug. The Injectiweld must be plugged into an outlet that is properly installed and grounded. If you do not know if your power outlet is grounded, check with a qualified electrician. Do not modify the plug. If it will not fit the outlet, have the proper outlet installed by a qualified electrician.



Never touch the welding tip at any time, unless you are sure that it is cool. **Severe burns may result.** Wear heat resistant gloves when handling hot welder parts and ensure no loose clothing, no loose jewelry, and tie up loose hair. **NEVER LOOK DIRECTLY IN THE BARREL OR POINT TOWARDS ANYONE WHEN HEATED AS AIR BUILDUP CAN EXPULSE MOLTEN PLASTIC. ALWAYS STORE WELDER ON STAND WHEN NOT IN USE.**



Always unplug the welder by the plug and not the cord. Unplug the welder before examining it or when leaving the welder unattended. Ensure power cord is not a hazard and is visible at all times. Inspect the entire welder and cord before every use for damage.

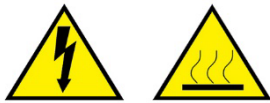

Never allow the welder's hot tip to touch the power cord as it could melt the wire's insulation and cause a dangerous condition. Stop use immediately and return welder to a service centre for a replacement cord if the hot tip touches the power cord or the cord shows any other physical damage.



Protect your eyes from hot plastic. While operating the welder, wear safety glasses. Ensure all proper additional personal protection equipment is worn in accordance with the local rules and regulations. Also ensure there are no flammable materials nearby, and that the tip will not contact any live electrical components while welding.



Consider your work environment. Do not immerse the welder in water, expose it to rain, or use it in excessively damp or wet environments. The welder is intended for indoor use only and not for use in marine, corrosive or caustic environments, and avoid allowing any foreign matter to enter the welder housing. Keep the welder vents clean and free of debris.



Use the welder in well ventilated areas free of flammable or oxygen enriched environments. Some plastics may give off noxious gasses as they melt. Know the plastic that you are working with and use breathing protection if warranted or if you have a sensitivity to any of the materials used in the welder.

Keep the work area well lit, clean, and free from hazards for maximum safety. Take breaks and do hand finger exercises often and ensure proper hydration. Ensure you are wearing suitable personal protection equipment (PPE) including safety glasses, hearing protection, adequate footwear and non flammable clothing.

Use only certified Drader replacement parts installed by a Drader Certified Repair Centre.

4. New Welder Details

Please fill out the information below for future reference. **Once completed, photocopy this page and email it to Drader Manufacturing. This will register your welder.**

Company Name: _____

Serial Number: _____ Date of Purchase: _____

Name of Distributor (if applicable): _____

Technical Data:

Model:	245	Rod Diameter [Ø]:	5/32 inch (.156) 4 mm
Power:	120 Volt / 60 Hz 240 Volt / 50 Hz	Fuse Rating:	1 x 3.15A Fuse (120 Volt) 2 x 2.5A Fuse (240 Volt - EU model) 1 x 2.5A Fuse (240 Volt - UK/AUS)
Watts:	160 Watt	Max Output (HDPE):	The product is intended for small repairs and limited construction only. Use the Drader Injectiweld W30000 when significant output is required.
Weight:	3.1 lb 1.4 Kg	Warranty:	One year - parts and labour
Temperature Range:	482 °F - 572 °F 250 °C - 300 °C		

5. Parts and Service

Call Drader Manufacturing (or your distributor) if you need to purchase parts, or to have your welder serviced. Have the welder serial number on hand.

Head Office

Drader Manufacturing Industries Ltd.

5750 – 50 Street
Edmonton, AB T6B 2Z8, Canada
Tel: +1 780 440 2231
Toll Free (North America): 800 661 4122
Fax: +1 780 440 2244
estone@drader.com
www.drader.com

Service Centre

(please refer to
www.drader.com for
nearest service centre)

Distribution Centre

(please refer to
www.drader.com for nearest
distribution centre)

6. Operating Instructions

This section will provide you with an overview of using the Injectiweld. Follow these steps to learn how to operate your welder.

- Unpack the welder and inspect the contents
- Select welding tip
- Plug the welder into an appropriate electrical outlet
- Set the temperature, then turn the welder on
- Feed the welding rod into the welder
- Make welds

Unpack the welder and inspect the contents

#	Description	Item ID #	#	Description	Item ID #
1	245 Injectiweld	Unique serial number		User Manual (not shown)	I2PAR-MANUAL
2	3/16" Fillet Weld Tip	I2TIP-316F		Carrying Case (not shown)	I2ASS-CASE
3	Repair Tip	I2TIP-RP		Heat-Resistant Glove (not shown)	I2CO-GLOVE
4	Scraping Blade	I2PAR-SCRBLD			
5	Stick Scraper	I2PAR-SCRSTK			
6	Hex Key	I2PAR-KEYTIP			
7	Welder Stand	I2ASS-WLD-STAND-SS			



The heated barrel and tip system:

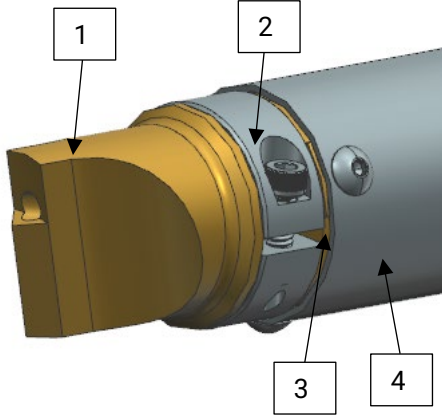

#	Item ID	Description
1	Various Item IDs	Tip
2	I2ASS-COLLAR	Collar Assembly
3	I2PAR-BARREL	Barrel
4	I2PAR-BARSLEEVE	Barrel Sleeve

Please note, there are other barrel parts that are not listed here.

Welding tip selection

The correct tip will make a difference on the quality and appearance of the weld. There are different tips for various applications. The two welder kit tips are the repair tip and the 3/16" fillet weld tip.

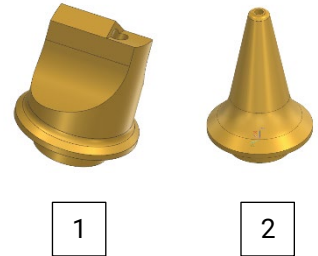

#	Description	Item ID	Main Usage
1	3/16" Fillet Weld Tip	I2TIP-316F	90° fillet welds, butt welds, repairs
2	Repair Tip	I2TIP-RP	Prototyping, repairs, filling holes, spot welding tight areas

The 245 Injectiweld kit comes with 2 tips. Both tips are versatile and can provide the operator with numerous types of welds. Tip choice is important as it determines the type of plastic weld. Use this manual to assist you in your tip choice.

Changing tips – the welder should be hot, but turned off



The tip and barrel will be hot. **Wear protective gear and heat-resistant glove to protect yourself from burns.**



When removing the collar, do not use excessive force. Excessive force will damage the tip and barrel.



The tip must be hot before changing, but the welder should be off and unplugged from mains power. The tip needs to be hot in order to melt the plastic in the transition area between the tip and the barrel.

Use a copper or brass brush to clean away burned plastic on the tip. Clean parts make heat transfer more efficient and will result in better more reliable welds.

- Place the welder on a flat, stable surface, with the collar screws facing up.
- Loosen the collar screws with the hex key (I2PAR-KEYTIP).
- Remove both screws.
- Remove both collar halves. If needed, give a slight nudge to both collar halves using the hex key.
- Using pliers or heat-resistant glove, pull the tip from the barrel, and place it on a heat-resistant surface.
- Use a copper, or brass brush to clean the old heat transfer compound from the barrel and tip.
- Place the tip onto the barrel. Pay attention to the position of the tip.
- Using the heat-resistant glove, place the lower collar onto the barrel and tip and hold it in place. Then place the upper collar half onto the barrel and tip, and then place the collar screws.
- Tighten the collar screws with the hex key (I2PAR-KEYTIP).

Plug the welder into an appropriate electrical outlet.

- Plug the welder in the appropriate electrical outlet (120V or 240V).

Set the temperature to turn the welder on.

- Plug in the welder and check for the blinking "o" on the display, indicating Sleep Mode.
- Use the plus (+) and minus (-) buttons to choose a temperature between 0 and 9.
- Once the desired temperature blinks:
 - Slow blink means heating.
 - Solid display means the barrel is at the set temperature.
 - Fast blink means the barrel is above the set temperature.

- During initial heating (slow blink), don't feed the rod. After that, its okay to weld, even if the display blinks slowly.
- LED Lights:
 - Lights are solid when a temperature is selected.
 - If solid or blinking, the welder is too hot to be put in the case; wait for the lights to go out (below 65°C).
- Sleep Mode:
 - Hold + or – button for 5 seconds to activate Sleep Mode.
 - Press any button to exit Sleep Mode.
- If the Trigger is inactive for 8 minutes, the welder enters Sleep Mode.
- Temperature settings:

#	Temperature °C	Temperature °F	#	Temperature °C	Temperature °F
T0	255 °C	491 °F	T5	280 °C	536 °F
T1	260 °C	500 °F	T6	285 °C	545 °F
T2	265 °C	509 °F	T7	290 °C	554 °F
T3	270 °C	518 °F	T8	295 °C	563 °F
T4	275 °C	527 °F	T9	300 °C	572 °F



The high temperature cutoff switch [HTCO] may shut the welder off if the temperature inside the welder housing exceeds the temperature limit. Once the welder cools off, the welder will operate normally; however, this can cause an unsafe condition so should the welder suddenly stop operating then the welder must be immediately returned to an authorized Drader Service Centre for repair.



Proper temperature is crucial for high quality welds. Set the proper temperature.

If you change welding materials and decrease the temperature, by the time you purge the original welding rod from inside the barrel, the welder should be cool enough to resume welding at the right temperature. If in doubt about the temperature, wait a few minutes.

Once the welder has reached the operating temperature check the collar screws and retighten if needed. Make sure not to overtighten it as it will damage the tip and barrel.

Temperature settings – Drader Injectiweld

Please contact your Drader Injectiweld representative before using a material that is not listed below.

Material	Description	Welder Setting	Temperature in °C	Temperature in °F
HDPE	High Density Polyethylene	T2	265 °C	509 °F
LLDPE	Linear Low-Density Polyethylene	T2	265 °C	509 °F
PP	Polypropylene	T5	280 °C	536 °F



WARNING / CAUTION - Do not use PVC [Polyvinylchloride] with the Injectiweld. The temperature and pressure used by the Injectiweld will degrade PVC and chlorine gas will be released. This aggressive gas is harmful, and it can damage the welder parts.



WARNING / CAUTION - Do not operate the welder until it has reached the set temperature.

Feed the welding rod into the welder

The Injectiweld Model 245 accepts 0.156-inch (4mm) diameter round welding rod. The feed is manual.

- Turn the rod release lever clockwise until the lever feels tight. This opens the rod drive wheels and allows them to accept welding rod.
- When the welder is powered up and the desired temperature is reached, feed the welding rod into the rod feed insert and push it up into the welder until it comes to a stop.
- Turn the rod release lever clockwise until the lever feels loose. This locks the rod into the feed mechanism.
- Depress the trigger to start feeding the welding rod into the welder.
- To remove the welding rod, turn the rod release knob clockwise until it is tight, then gently tug on the welding rod out of the welder. Note that this can only be done when the barrel is hot.
- If the welder isn't feeding the rod or rollers slip, adjust temperature or slow down welding speed (how fast you pull the Trigger).



When finishing off a roll of welding rod, remove the last remaining welding rod from the welder and start a fresh roll. This will reduce the chances of a rod jam.

When switching from one welding rod to another, clear the previous rod material by removing it from the feed tube, then feed the new welding rod. Purge about one meter (one yard) of molten welding rod to ensure old material has been purged.

7. Welding Joint Types

Fillet Welds

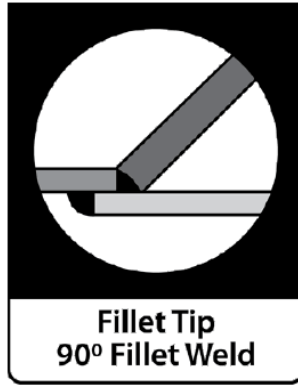
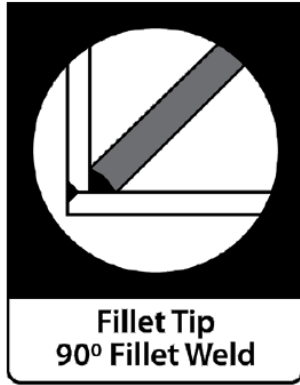

Fillet tips are used mainly for fillet welds [90°] and butt welds. The style of those tips allows one to weld from inside corners out and be able to seal the corners without changing to another tip style. Fillet tips can also be used for crack repairs, as long as the crack is somewhat straight. The longer preheat section allows faster welding speed than welding cracks with the conical tip.

Repair Tip, Prototype Tip

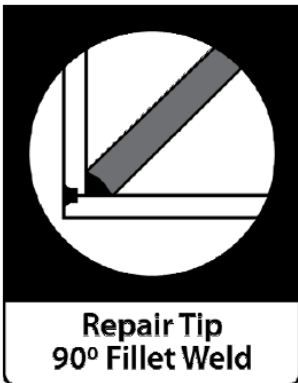

Repair tips are used for crack repairs, filling small holes, spot welding, for reaching tight areas, and for prototyping. Because of their conical shape, the repair tip and prototyping tip offer similar types of welds. Choose the size that best suits your application.



Ribbon Weld Tip

The Ribbon weld tip is used to make a seam weld on thermoplastic materials such as belting and thin sheets. Because this welding tip does not weld down to the root side, it should not be used for regular butt welds.

8. Proper Welding Techniques – General Considerations

Consider these variables when welding plastics.



Material

In order to achieve quality welds, ensure that the welding rod matches the parent material. For example, match polyethylene with polyethylene rod and match polypropylene with polypropylene rod.



Do not expect a quality weld if the parent material and welding rod do not match.



Heat

Each plastic melts within a certain temperature range. When you drift outside this zone, the weld quality diminishes.

Some people turn up the heat in order to weld faster, yet they sacrifice weld strength. Do not be tempted to weld faster by raising the weld temperature!



Pressure

Pressure allows the plastic molecules of the materials to mix. Best bonding occurs when there is a physical mixing of the plastics.

Pressure, when too high or too low, reduces weld quality.



Time

Plastic needs time to melt and time to cool down. Do not speed up the cooling time. After welding, plastic molecules need 24 hours to come to a complete rest.



Plastic should be at “room temperature” for at least 24 hours before it is welded.

9. Proper Welding Techniques – Drader Injectiweld

Optimal Root Penetration (welding one side)

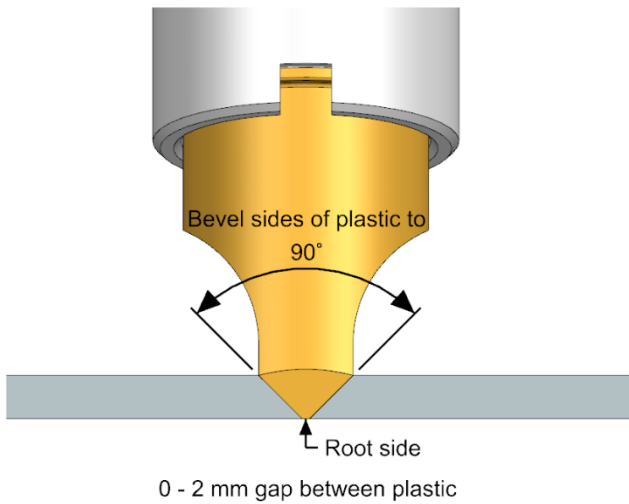

Welding from one side

- Butt welding two sheets together
- Plastic crack repair

Bevel each side of the plastic so that their combined angle is 90 degrees.

You may use the stick scraper to give you the proper angle.

Leave a gap between the parent materials so that molten welding rod can penetrate the root.

Excess welding rod may be trimmed off (after it cools). You may use the scraping blade to perform this function.

Optimal Weld Size (welding both sides)

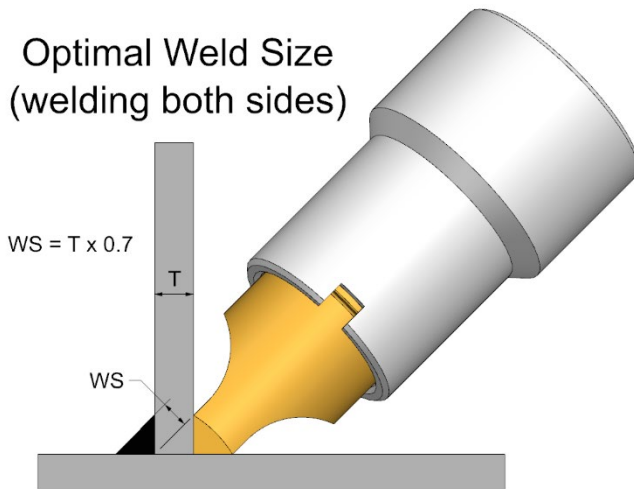

WS = Weld Size
T = Plastic Thickness

Welding from two sides



- Fillet welding two sheets together

The amount of welding rod injected onto the parent material should be about 70% of the thickness of the thinnest plastic sheet.

Increase or decrease welding rod thickness by:

- Changing tips
- Adjusting the speed of how fast your welder travels

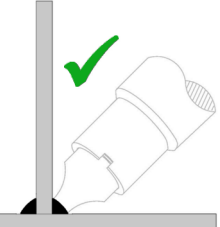
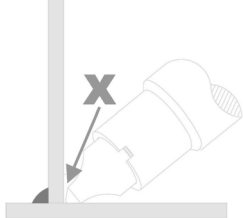
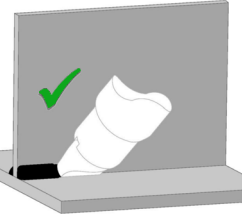
10. Proper Welding Techniques – Drader Injectiweld – Fillet Welds

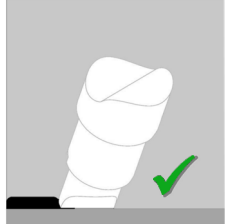
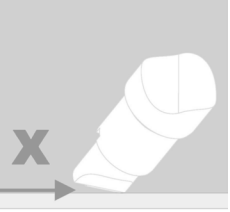
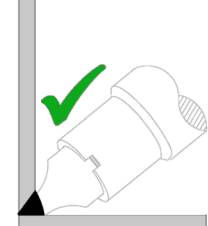
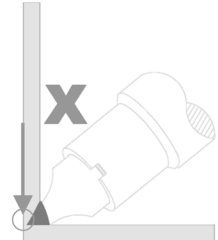
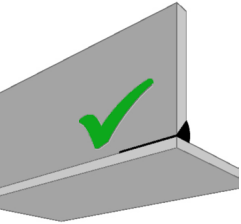
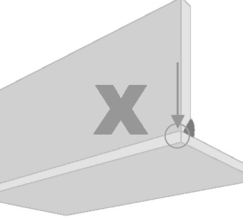
Fillet Welds – Correct Alignment	Fillet Welds – Incorrect Alignment
 <p>Welding tip is in correct alignment when it is at a 45° angle</p>	<p>Welding tip is not in correct alignment when the fillet weld tip is not at a 45° angle or when it does not come into contact with both sides of the parent plastic material</p> 
 <p>Welding tip is in correct alignment when it is flat against both sides of the parent plastic material</p>	<p>Welding tip is not in correct alignment when the bottom edge is not flat against the parent plastic material</p> 
 <p>Welding tip is in correct alignment when it is flat against both sides of the parent plastic material</p>	<p>Welding tip is not in correct alignment when the bottom edge is not flat against the parent</p> 
 <p>When welding from one side, leave a root gap of 1 to 2 mm so that welding rod can penetrate to the other side</p>	<p>Lack of penetration to the root will result in a poor weld quality</p> 
 <p>Welding rod should penetrate to the root side of the parent plastic</p>	<p>Since molten welding rod did not penetrate the root, a poor weld quality will result</p> 

11. Proper Welding Techniques – Drader Injectiweld – Butt Welds

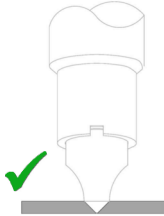
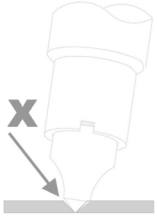
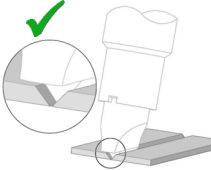
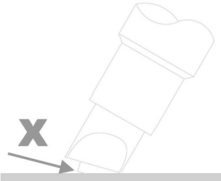
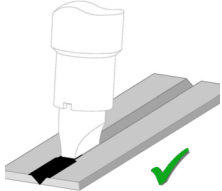
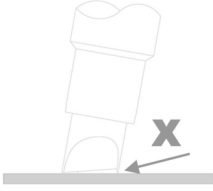
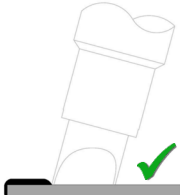
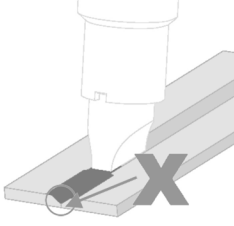
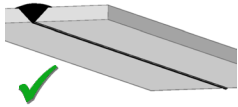
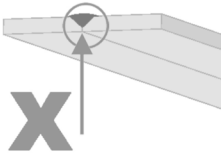
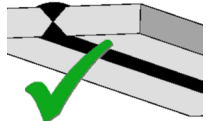
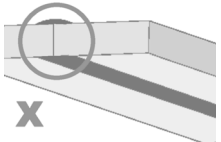
Butt Welds – Correct Alignment	Butt Welds – Incorrect Alignment
 <p>Welding tip is in correct alignment when it is at a 90° angle</p>	<p>Welding tip is not in correct alignment when it is not at a 90° angle</p> 
 <p>Welding tip is in correct alignment when it can reach the root of the other side of the parent plastic material</p>	<p>Welding tip is not in correct position when its melting surface does not contact the parent plastic material</p> 
 <p>Welding tip is in correct alignment when its edges contact each side of the parent plastic material</p>	<p>Welding tip is not in correct position when its melting surface does not contact the parent plastic material</p> 
 <p>Welding tip is in correct alignment when molten welding rod penetrates the root of the parent plastic material</p>	<p>Welding tip is not in correct alignment if molten welding rod cannot penetrate the root</p> 
 <p>If welding from one side, welding rod must fill the root of the parent plastic material</p>	<p>A poor weld will result if molten welding rod did not penetrate the root</p> 
 <p>If you can weld from both sides, make two 90° bevels before welding</p>	<p>Lack of penetration will result in a poor butt weld</p> 

12. Daily Maintenance – Drader Injectiweld

A well-maintained welder will give you years of service.



Use a copper (or brass) brush to clean away burned plastic around the tip. Clean parts make heat transfer more efficient.

We highly recommend you purchase the welder stand (I2ASS-WLD-STAND-SS). After you are finished welding place the welder in the stand to cool off.

13. Compliance Statements For Drader Injectiweld Products

EU DECLARATION OF CONFORMANCE:

The declaration of conformance for the EU outlines conformance to EMC, safety, and environmental directives allowing for the CE mark to be applied. You can access the declaration at <https://www.drader.com/compliance>.

WEEE COMPLIANCE:



Drader Manufacturing is compliant with the European Community directive 2002/96/EC (Waste Electrical & Electronic Equipment, WEEE) with respect to products sold within the European Union. This directive restricts the disposal of electronic equipment and states that it must be marked to indicate it is not to be disposed of in unsorted waste starting August 13, 2005. This marking has been added to Drader products sold in the EU. **Do not dispose of electrical equipment with household refuse!**

CALIFORNIA PROPOSITION 65 WARNING:

WARNING: This product contains and may produce through its normal use chemicals known to the State of California to cause cancer and birth defects or other reproductive harm.

CONFLICT MINERALS DECLARATION:

In August of 2012 the Securities and Exchange Commission established rules in response to the Dodd-Frank Wall Street Reform and Consumer Protection Act, which requires companies to disclose their use of Conflict Materials that originated in the Democratic Republic of the Congo (DRC) or adjoining countries. As of the date of this document, these materials include tantalum, tin, gold, and tungsten. To the best of our knowledge none of Drader's products contain any Conflict Minerals.

UNITED STATES OF AMERICA EMC STATEMENT OF COMPLIANCE

This equipment has been tested and found to comply with the limits for a Class A digital device, pursuant to Part 15 of the FCC Rules. These limits are designed to provide reasonable protection against harmful interference when the equipment is operated in a commercial environment. This equipment generates, uses, and can radiate radio frequency energy and, if not installed and used in accordance with the instruction manual, may cause harmful interference to radio communications. Operation of this equipment in a residential area is likely to cause harmful interference, in which case the user will be required to correct the interference at his own expense.

This device complies with Part 15 of the FCC Rules. Operation is subject to the following two conditions:

- 1) this device may not cause harmful interference, and
- 2) this device must accept any interference received, including interference that may cause undesired operation.

CANADA EMC STATEMENT OF COMPLIANCE

This Class A device complies with Canadian ICES-001 rules / CSA CISPR 11:19.

Cet appareil numérique de la classe A est conforme a la norme NMB-001 du Canada / CSA CISPR 11:19.

14. Warranty

A. Warranty

Drader Manufacturing Industries Ltd. (“**DRADER**”) warrants new 245 Injectiweld Welders manufactured by DRADER (the “**Welder**”) and any new accessories and replacement parts for the Welder (the “**Parts**”) (the Welder and the Parts hereinafter collectively referred to as the “**Injectiweld Products**”) against manufacturer defects in workmanship and materials under normal use and conditions for a period of 1 year (“**Warranty Period**”) from the date of first purchase from DRADER or an authorized distributor of Drader (“**Authorized Distributor**”). Customer shall, prior to making a warranty claim, first utilize support materials shipped with the Injectiweld Products, product diagnostics, information contained on the internet and e-mail support.

If there is a manufacturer defect in any of the Injectiweld Products (such defective Injectiweld Products hereinafter referred to as the “**Defective Products**”), as determined by DRADER in its sole and unfettered discretion, and a written claim is received with respect to the Defective Products by DRADER or an Authorized Distributor prior to expiry of the Warranty Period, then, at DRADER’s option, DRADER will either:

1. repair the defect in material or workmanship with respect to such Defective Products; or
2. furnish new, repaired or refurbished Injectiweld Products (such Injectiweld Products to be for the same purpose as the Defective Products) of equal value, in exchange without charge (except for fees associated with shipping, handling, packing and insurance as provided herein).

DRADER warrants repaired and replaced Defective Products provided hereunder against defects in materials and workmanship from the date of the repair or replacement for the remainder of the original Warranty Period. If the Defective Products are exchanged, the replacement Injectiweld Products become the customer’s property and the Defective Products become DRADER’s property. The customer is responsible for all costs of shipping the Defective Products to DRADER and DRADER shall be responsible for the cost of returning the repaired Defective Products or replacement Injectiweld Products (whichever is applicable) to the customer only if the warranty claim is deemed to be valid as provided herein (if the warranty claim is rejected by DRADER, the customer will be charged for the cost of all authorized repairs/replacements as well as shipping the Defective Products and/or Injectiweld Products back to the customer). Shipping for warranty claims handled by an Authorized Distributor will be handled in accordance with the Authorized Distributor’s standard policies and procedures regarding shipping warranty repaired products, which may differ from those of DRADER.

B. Warranty Exclusions

The limited warranty provided herein is non-transferable, applies only to new Injectiweld Products purchased directly from DRADER or from an Authorized Distributor and is only available in the event the customer uses the Injectiweld Products under normal operating conditions as provided in written use instructions, if any (either in writing with the Injectiweld Products or online as provided by DRADER).

1. The limited warranty provided herein shall not apply to any Injectiweld Products, and DRADER shall not be

obligated under this warranty, to repair any defect, failure or damage to Injectiweld Products which, in the sole and unfettered discretion of Drader, are in any way the result of:

- (a) Accident, abuse or improper use of the Injectiweld Products;
- (b) Attempts by personnel, other than personnel of DRADER, to install, repair or service the Injectiweld Products unless directed by DRADER personnel and confirmed in writing;
- (c) Modifications or alterations not approved by DRADER in writing;
- (d) The customer failing to properly or adequately maintain and clean the Injectiweld Products as prescribed in published product materials and industry norms; and
- (e) Using the Injectiweld Products in an environment not meeting the operating specification set forth by DRADER for the Injectiweld Products.

2. In addition to the exclusions provided in Paragraph B1 above, the limited warranty provided herein does not:

- (a) Apply to previously used Injectiweld Products;
- (b) Apply to any Injectiweld Products where the serial number or the serial number of any of its parts has been altered, defaced, or removed;
- (c) Apply to labels on the Injectiweld Products;
- (d) Apply to normal wear and tear of the Injectiweld Products;
- (e) Cover damage or loss incurred in transportation of the Injectiweld Products;
- (f) Cover replacement or repair necessitated by loss or damage from any cause reasonably beyond the control of DRADER, such as lightning or other natural and weather-related events or wartime environments; and
- (g) Cover any labor involved in the removal and or reinstallation of warranted Injectiweld Products on site, or any labor required to diagnose the necessity for repair or replacement.

For greater certainty and the avoidance of doubt, DRADER does not warrant the quality of any welds or repairs made by a welder using the Injectiweld Products.

C. Limitation of Liability

For greater certainty and the avoidance of doubt, the warranty provided herein is limited to the remedies provided in Paragraph A1 and A2 above and specifically excludes any responsibility by DRADER for incidental or consequential damages arising from the use of Injectiweld Products, or for any inability to use them either separate from or in combination with any other equipment or products.

To the extent permitted by law, the warranty provided herein is strictly in lieu of: a) any other conditions or warranties, express or implied, oral or written, statutory or otherwise, including, but not limited to, any implied warranty of merchantability or fitness for purpose; and b) any and all obligations and liabilities of DRADER for damages including but not limited to accidental, consequential, or special damages, or any financial loss, lost profits or expenses arising from or out of or in connection with the use or performance of the Injectiweld Products, even if DRADER has been advised of the possibility of such damages. DRADER shall not be liable for any claim made by a third party or made by the customer on behalf of a third party.

If any term or condition of this limited warranty or the application thereof to any person or circumstance will, to any extent, be held to be invalid or unenforceable by applicable laws (including but not limited to consumer protection legislation in the jurisdiction of the customer), the remainder of this limited warranty and the application of that term or condition to persons or circumstances other than those as to which it is held invalid or unenforceable, will not be affected thereby and each term and condition of this limited warranty will be valid and enforced to the fullest extent permitted by law. DRADER and the customer acknowledge and agree that the court having jurisdiction over any dispute in this warranty shall have, and hereby expressly grant to such court, the express power and authority to read down and/or sever any offending provisions herein to the extent required to make any such covenant enforceable. The court is hereby advised and instructed that it is the intention of DRADER and the customer that the provisions of this limited warranty be amended to the minimum extent required to make such provisions reasonable and enforceable in the circumstances, as determined by the court in its discretion. Drader and the customer acknowledge and agree that, for the purposes of this limited warranty, the laws of the country of purchase (the location of DRADER or Authorized Distributor, as applicable, who receives and processes the order of Injectiweld Products for the customer) of the Injectiweld Products shall apply and shall be considered the applicable law herein.